

CyberView X5 SF User's Manual



FEDERAL COMMUNICATIONS COMMISSION (FCC) STATEMENT

This Equipment has been tested and found to comply with the limits for a class B digital device, pursuant to Part 15 of the FCC rules. These limits are designed to provide reasonable protection against harmful interference in a residential installation. This equipment generates uses and can radiate radio frequency energy and, if not installed and used in accordance with the instructions, may cause harmful interference to radio communications. However, there is no guarantee that interference will not occur in a particular installation. If this equipment does cause harmful interference to radio or television reception, which can be determined by turning the equipment off and on, the user is encouraged to try to correct the interference by one or more of the following measures:

- Re-orient or relocate the receiving antenna.
- Increase the separation between the equipment and receiver.
- Connect the equipment into an outlet on a circuit different from which the receiver is connected to.
- Consult the dealer or an experienced radio/TV technician for help.

Warning :

Use only shielded signal cables to connect I/O devices to this equipment.

You are cautioned that changes or modifications not expressly approved by the party responsible for compliance could void your authority to operate the equipment.

TABLE OF CONTENTS

Getting Started	4
Quick Installation Guide (QIG)	6
Installing Software and Driver	6
Installing Hardware	8
Inserting 35mm Slides	8
Inserting 35mm Film strips	9
Additional Features	10
One Button Scan (PC ONLY Feature)	10
How to Scan Film and Slides	11
STEP 1 - Acquire Driver	
STEP 2- Select Film Type	
STEP 3 - Optional Prescan	
STEP 4 - Set Scan Settings	13
STEP 5 - Set Scan Preferences	16
STEP 6 - Scan	17
STEP 7 - Exit	17
User Interface	22
I Main Window Area	18
Scan Setting Reference	18
II Preview Window Area	19-21
III Active Frame Setting Area	27
IV Thumbnail Panel Area	28
Technical Support	30

GETTING STARTED

Check the package content before getting started.

For Quick Installation please refer to Quick Installation Guide. (Ref. Pg. 6)

Important! Save the original box, receipt and packing material for future shipping needs.

Package Contents

- Film Scanner.
- Power Adapter

Warning! Using any other power adapter may severely damage the scanner and will void the product warranty.

- USB 2.0 Cable.
- SilverFast SE 3rd party Scanning software CD

GENERAL GUIDANCE:

- Only use the supplied USB-Cable. Connect the computer to the scanner directly using the USB 2.0 cable.
- For systems using USB 3.0 (USB-C mini port) a Hub may be required please see [Connectivity issues with my new scanner](#)
- If your situation requires a longer USB cable, use only cables 6ft or less in length, do not use a cable extender, Also for best connectivity on Desktop computers use only the rear USB ports
- If there are any other devices (multifunction devices, i.e. printers, scanners, web- cam) connected to the computer through USB you may need to disconnect them, this does not apply to Wi-Fi connected devices
- A minimum of 1 GB RAM (Windows/Mac) is required, 2GB or more highly recommended.

Operating Ambient Temperature Range
50° to 104°F (10° to 40°C)

Note: Do not turn on the scanner unless it is within this range. If the scanner has been stored or transported outside of this range, allow it to return to within this range before turning it on.

Operating Ambient Humidity Range 15% to 76% relative humidity (non-condensing)



Note: If the scanner is stored or to be transported in cold temperature and then brought into a warm / humid environment condensation may occur.

QUICK INSTALLATION GUIDE

INSTALLING SOFTWARE AND DRIVER

Installing Scanner Driver

NOTE: Make sure the scanner is NOT connected to the computer during the Cyber-View X 5.0 driver installation.

- a. Download the CyberView X scanning software from the website [Download Drivers Click Here](#)
- b. **PC – Open the download location** Double click the "CyberView" icon  to open the zipped file
- c. Click on the CyberView X_Windows installer  to begin the installation, follow the onscreen prompts

MAC – Download the driver from the above link, then click on the CyberViewX_Mac file in the downloads folder this will create a CyberView removable drive icon on the desktop, Open your Applications folder next open the CyberView drive and drag the CyberView icon into the Applications folder to install it.

Please Note: When installing your new scanner onto a Windows system that already has another **USB** Scanning device **CONNECTED**

EXAMPLE: Flatbed scanner or All-in-one Scan/Copier/Printer device, it may be necessary to power off or if there is no on/off switch disconnect the other scanner from the USB port for the Film scanner to work properly,

Installing Hardware a. Connect the slide scanner to a power source.

1. Locate the power switch on the lower left t side back of the scanner. Make sure the scanner is TURNED OFF.



2. Plug the AC adapter into an AC power source FIRST before plugging it into the scanner.

3. Attach the USB cable to the computer using the standard USB adapter end. Attach the U shaped USB adapter end of the cable to back panel of the scanner.

- 1. Scanner
- 2. Slide holder
- 3. Film Holder
- 4. One Button Scan
- 5. Back of the unit
- 6. Viewing Window

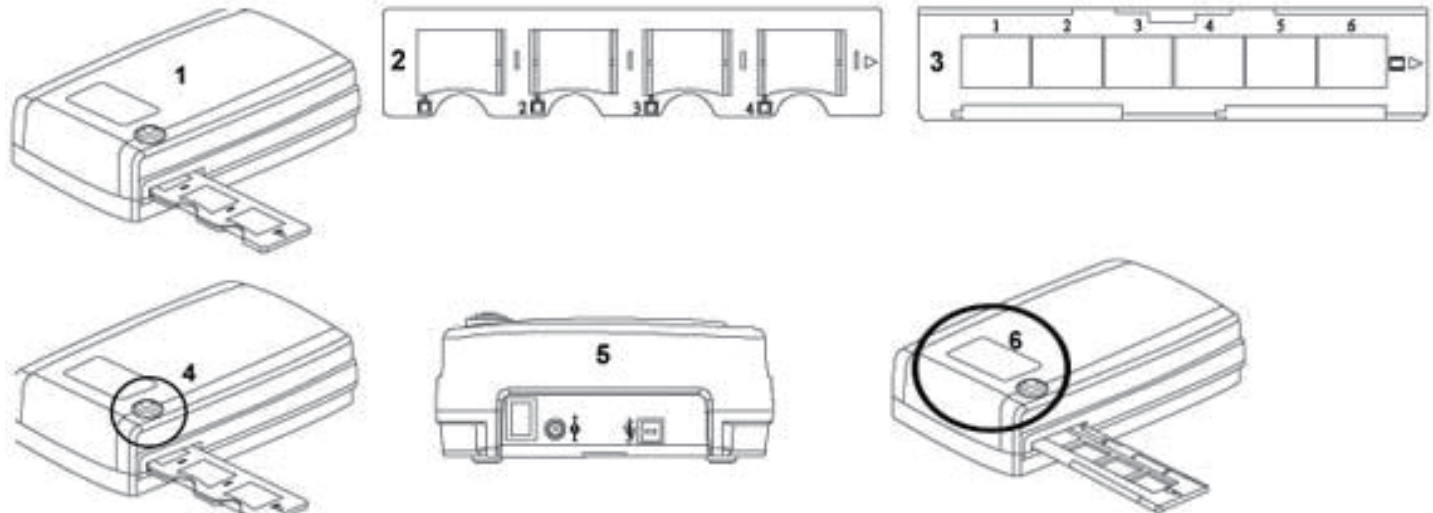

Mounted Slides

- 1-1. Load the mounted slides into the slide holder, shiny side facing upward
- 1-2. Insert the slide holder into the scanner with the arrow facing upwards
- 1-3. Insert to holder into the scanner from the left or the right side

Please Note: improper insertion will cut off the top of the image.

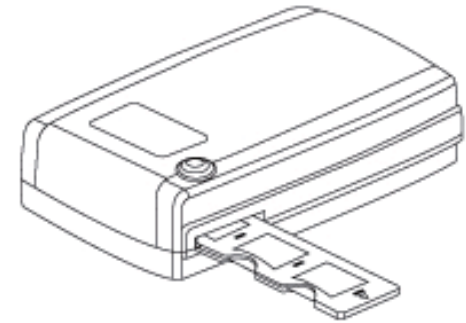
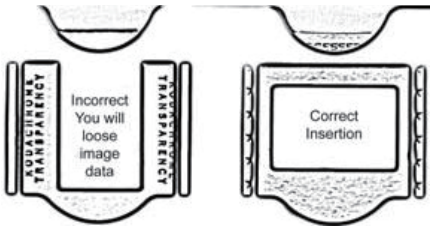

2. Set Scan settings and preferences See Page 13

Negative Film Strips

- 2-1. Load the negative into the holder making sure to align the film frames with the frames on the holder, and with the shiny side facing upward
- 2-2 Close the film holder
- 2-3. Insert the film holder into the scanner from the left or right side, with the arrow facing upwards

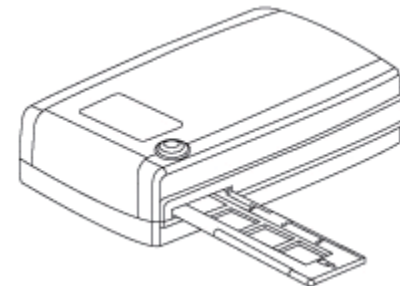
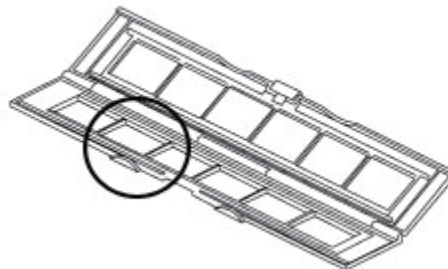
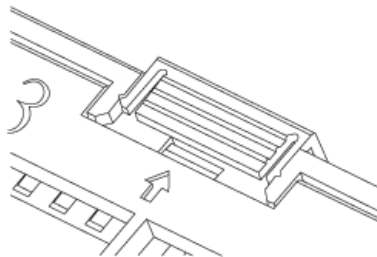

Additional features

One Button Scan (PC ONLY)

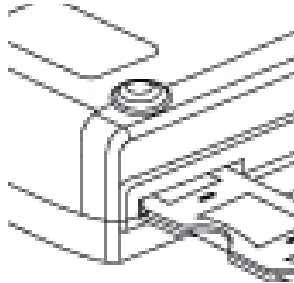

1. FIRST you must Open the CyberView software (see page 10 to acquire the CyberView driver program)
2. Configure Scan Settings (see Page 12)
3. Select the Scan to directory, file format (TIF or JPG, once configured, Press the scanner button) to begin scanning.

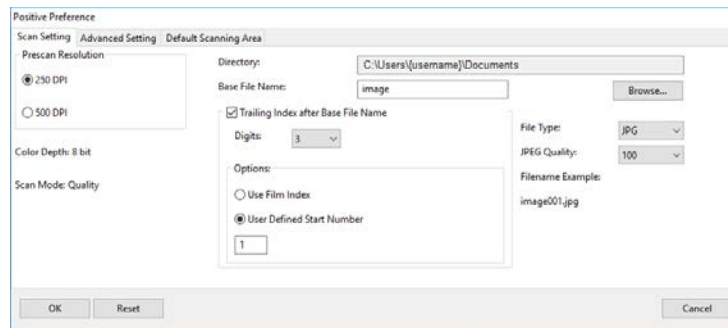

NOTE: If you do not open CyberView FIRST, the scan button will not function.

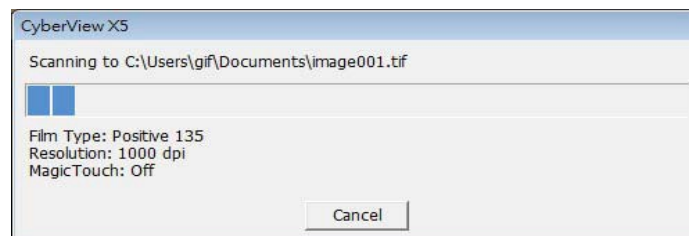

HOW TO SCAN

STEP 1 – Turn on the scanner wait for the flashing light to come on steady indicating the hardware is ready to use.

Acquire Driver

(For PC User) Open CyberView from Start – All Programs –CyberView or desktop icon

(For MAC User)

Open Macintosh Hard drive – Applications –CyberView X.app or from the Apple menu Go – Applications – CyberView X.app



STEP 2 – Select Film Type

Select the film type to be scanned – Positive , Negative or B&W (Black and White).



STEP 3 – Optional Prescan (To be used if you wish to pre-edit the images before final scan)

Select the “Prescan Current Frame” to Prescan the slide currently loaded into the scanner or “Prescan All..” to Prescan an entire negative strip

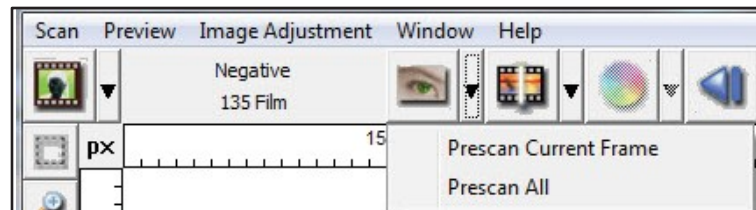

HOW TO SCAN...cont.

STEP 4 – Set Scan Parameters

Notice: Higher scanning resolutions result in greater scanning time and hard disk space requirements.

a. Resolution

The default scanning resolution is 1000dpi, additional resolution options are listed below.

b. Color Depth

Choose between 8 and 16bit. A higher color depth setting will result in a larger range of colors in the final scanned image.

The Film Scanner color depth is 48 bit true color. The scanning software has the capability of selecting 8 bit color mode or 16 bit color mode when scanning, This will produce 24 or 48 bit color images, 8 bits or 16 bits per Red, Green and Blue color channels.

Example:

8 bit mode = 8 Red, 8 Green, and 8 Blue for a total of 24 bit color

16 bit mode = 16 Red, 16 Green, and 16 Blue for a total of 48 bit color”

Scan Mode –Fast, Normal mode produces a scan in JPEG format while Quality produces a non-compressed, “loss-less” TIFF image.

Scanning Resolution	Color Depth (by RGB channel)	Color Mode	File Size TIFF (no compression)
300dpi	8 bit	24-bit	~350Kb
600dpi	8 bit	24-bit	~1MB
1800dpi	8 bit	24-bit	~12MB
3600dpi	8 bit	24-bit	~52MB
7200dpi	8 bit	48-bit	~208MB

Set Scan Preferences

Select Scan - Preference - Film Type - Scan Setting or click the Settings icon on the main user interface

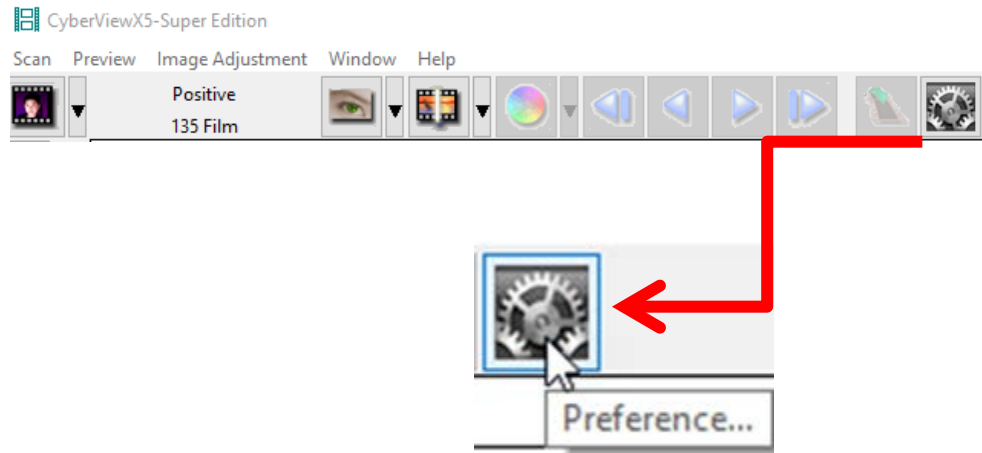
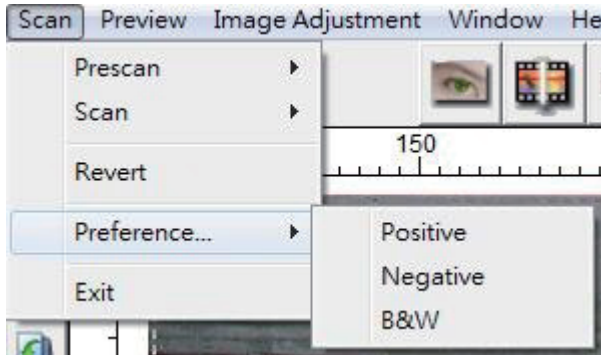

This opens the main settings window

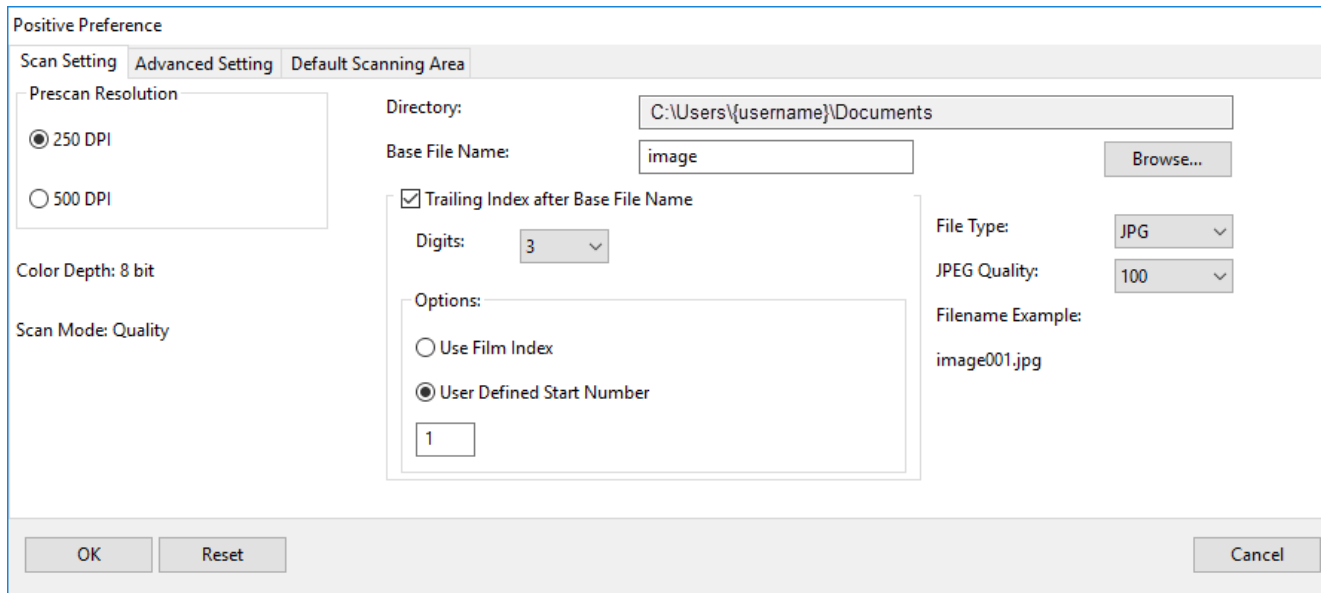

Scan Setting

The screenshot shows the 'Scan Setting' dialog box with the following elements and callouts:

- 1**: Prescan Resolution (radio buttons for 250 DPI and 500 DPI)
- 2**: Directory (text field with 'C:\Users\blues\Documents\')
- 3**: Base File Name (text field with 'image' and a 'Browse...' button)
- 4**: Trailing Index after Base File Name (checkbox, checked)
- 5**: Color Depth (8 bit)
- 6**: Options (radio buttons for 'Use Film Index' and 'User Defined Start Number', with a text field for '1')
- 7**: File Type (dropdown menu with 'JPG' selected)
- 8**: OK button
- 9**: Reset button
- 10**: Cancel button

- 1 Prescan Resolution:** use this when prescanning only, the 500 dpi setting produces a larger prescan view when in full screen mode
- 2 Directory:** Select where the files are saved to, Documents is the default setting, to change select Browse and choose a different location
- 3 Base File Name:** This is the file name applied to every image which will then have a number after it, image is the default
- 4 Trailing Index after Base File Name:** This is the number length, digits 3 default file name example image001, you can select 1-6 digits for the number length
- 5 Color Depth:** These can be configured in the Active Frame settings window 8 bit is 8 bits per RGB channel = 24 bit color mode, 16 bit is 16 bits per color channel = 48 bit color mode **Scan Mode:** Normal for standard photographic images, Quality for high definition images such as x-rays, Quality mode results in a slower scan speed
- 6 Options:** **Use Film Index;** the software automatically numbers the files
User Defined Start Number: Allows for more custom numbering of the files
- 7 File Type:** **TIF;** Full uncompressed image, **JPG;** uses JPG compression to reduce the file output size JPG only supports 8 bit image output
- 8 OK:** Saves the settings applied and closes this window
- 9 Reset:** Resets the software to ALL Factory Defaults
- 10 Cancel:** Closes this window and no settings will be saved

Advanced setting

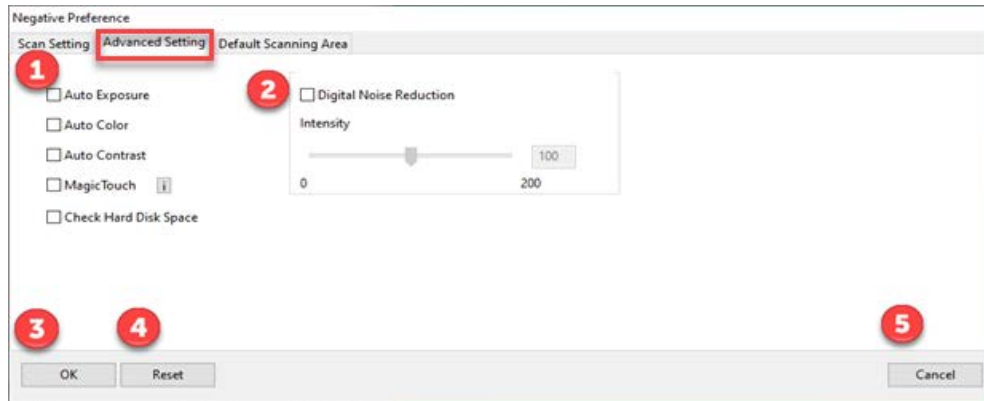

1

Auto Exposure: Automatically adjusts the image exposure, on by default
Auto Color: Corrects image colors when activated
Auto Contrast: Adjusts image contrast when enabled
Magic Touch: Removes dust and scratches when enabled

2

Digital Noise Reduction: This reduces digital film grain on higher speed films, do not use on 100 aa or slower as it will cause image degradation

3

OK: Saves settings and returns to main interface

4

Reset: Restores factory defaults on ALL Settings

5

Cancel: Closes settings and returns to main interface without saving changes

Default Scanning Area

Positive Preference

Scan Setting Advanced Setting **Default Scanning Area**

1 Enable user setting for auto-crop

	Width	Height	
Scan Size	3.649980	2.429764	Default
Scan Offset	Offset X 0.000000	Offset Y 0.000000	Default

2 OK 3 Reset 4 Cancel

1 Enable user setting for auto-crop: This allows you to configure a smaller than standard 35mm scan area so it applies the same to every scan, this can be useful when scanning 110 slides, it cannot be set outside the 36.5 x 24.5 maximum scanning area, so there is no ability to capture the film sprocket area outside these dimensions

2 OK: Returns you back to the main software interface and saves your settings

3 Reset: Restores ALL settings back to factory defaults

4 Cancel: Returns you back to the main software interface without saving your settings

Scan

Prescan – Prescan Current frame

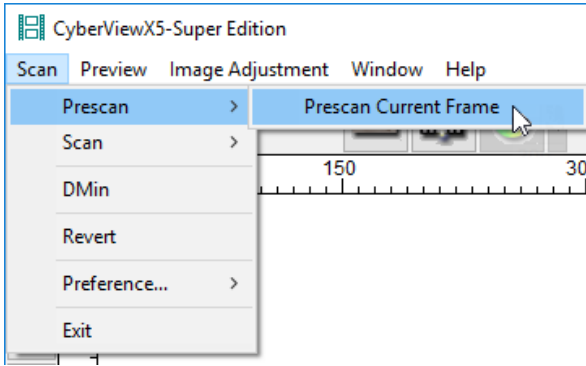

NOTE: ONLY Prescanned images appear in the Preview window
Scanned images go directly to the designated folder

Scan - Scan-

Scan Current Frame: Scan current image in the viewing window

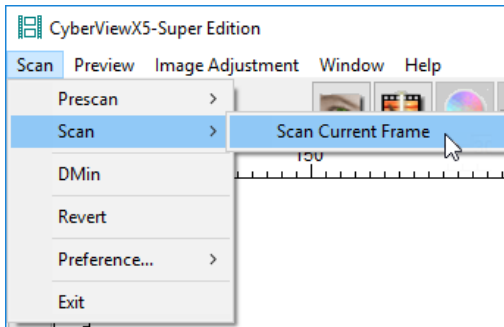

Calibrating

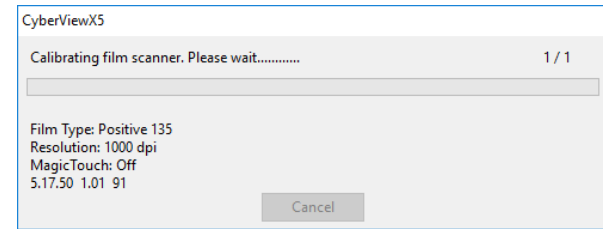

Measuring the films density

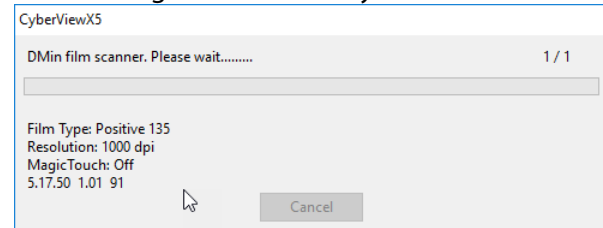

Scanning

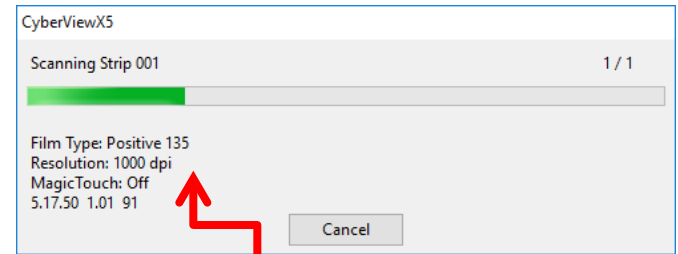

Scanning stats:
Film Type selected
Scan dpi
Scratch removal
Software / Firmware / Hardware version

USER INTERFACE

The screenshot displays the CyberViewX5-Super Edition software interface. The main window features a menu bar with 'Scan', 'Preview', 'Image Adjustment', 'Window', and 'Help'. Below the menu is a toolbar with icons for film, eye, film strip, color wheel, and a gear. The central 'Main Preview area' is a large white space with a ruler at the top and left, showing pixel dimensions (px) up to 600 and 300. A red arrow points to this area with the text 'Main Preview area'. To the right, a 'Scan Setting' panel is open, showing 'Scan Mode' set to 'Normal', 'DPI' set to '1000', 'Width' at '1437.00', 'Height' at '957.00', and 'Color Depth' at '8 bit'. A red arrow points to the 'Advanced>>' button in this panel with the text 'Scan settings Set DPI Color Depth View image measurements'. The bottom status bar shows 'R:0 G:0 B:0', 'X:0 Y:0', 'Exposu Zoom Scale:100%', 'Location:1', and 'Selections:0'.

There are four major parts of the CyberView X 5 user interface:

I. Main Window Area [Fixed Windows]

II. Preview Window Area [Fixed Window]

III. Active Frame Setting Area [Floating Window]

I. Main Window Area [Fixed Windows]

Menu Commands - Scan

Prescan - Prescan Current Frame: Pre-scan the existing slide.

Scan - Scan Current Frame

DMin – Measures the film density when enabled

Revert – Resets Color changes back to original

Preference- Opens Scan setting window - **See Scan Setting (See Page 13)**

Exit - Closes the CyberView X5 user interface.

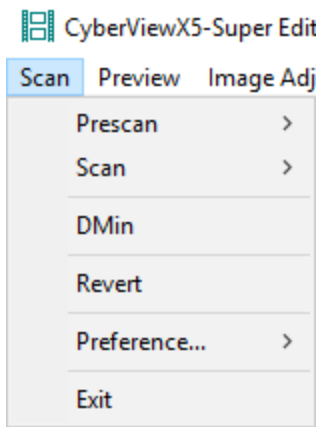

Menu Commands - Preview (overview)

Zoom, Rotate & Flip features.

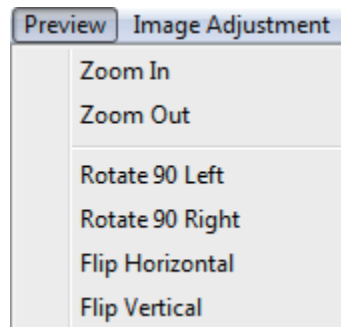

Menu Commands - Image Adjustment

a. Image Adjustment

1. Variations: Generates different views of image with options to make changes to highlights, mid-tones, etc.

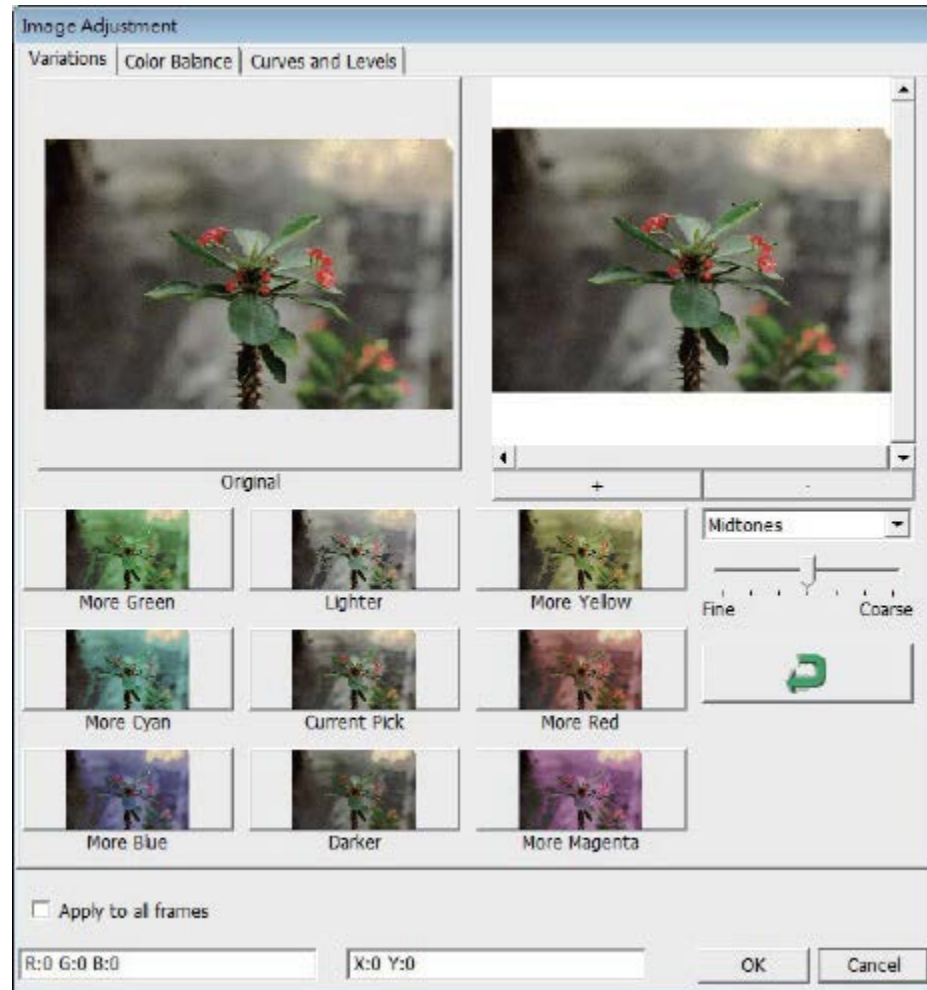
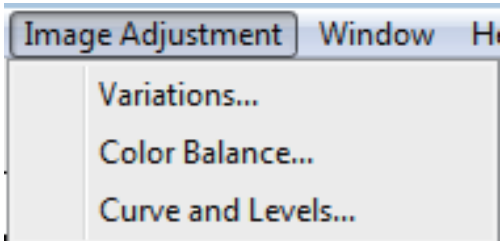

2. Color Balance

To adjust the brightness, contrast, saturation, and color (CMY or RGB) of the image. Comparisons between before and after adjusted images are shown for reference

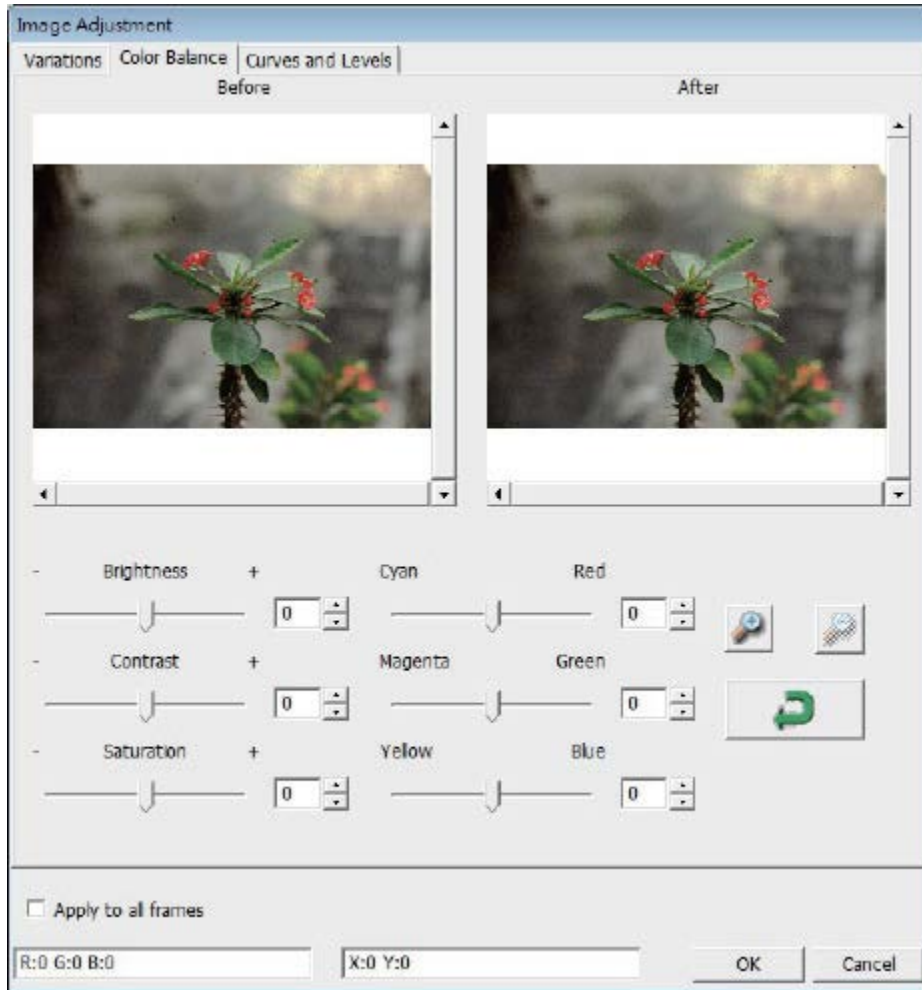

Example: If a previewed image appears too dark, use the "Brightness" slider in the "Color Balance" window to adjust the image by selecting the slider in the center and moving it to the right. The image's "After" view becomes lighter. Select "OK" to accept the changes which will be sent to the scanning hardware. This can also be used to adjust each of the functions in "Color Balance" by contrast, saturation and specific color ranges of cyan, magenta and yellow.

3. Curves and Levels

Adjust image settings by moving Curve and Levels settings. Comparison between before and after adjustment is displayed for reference.

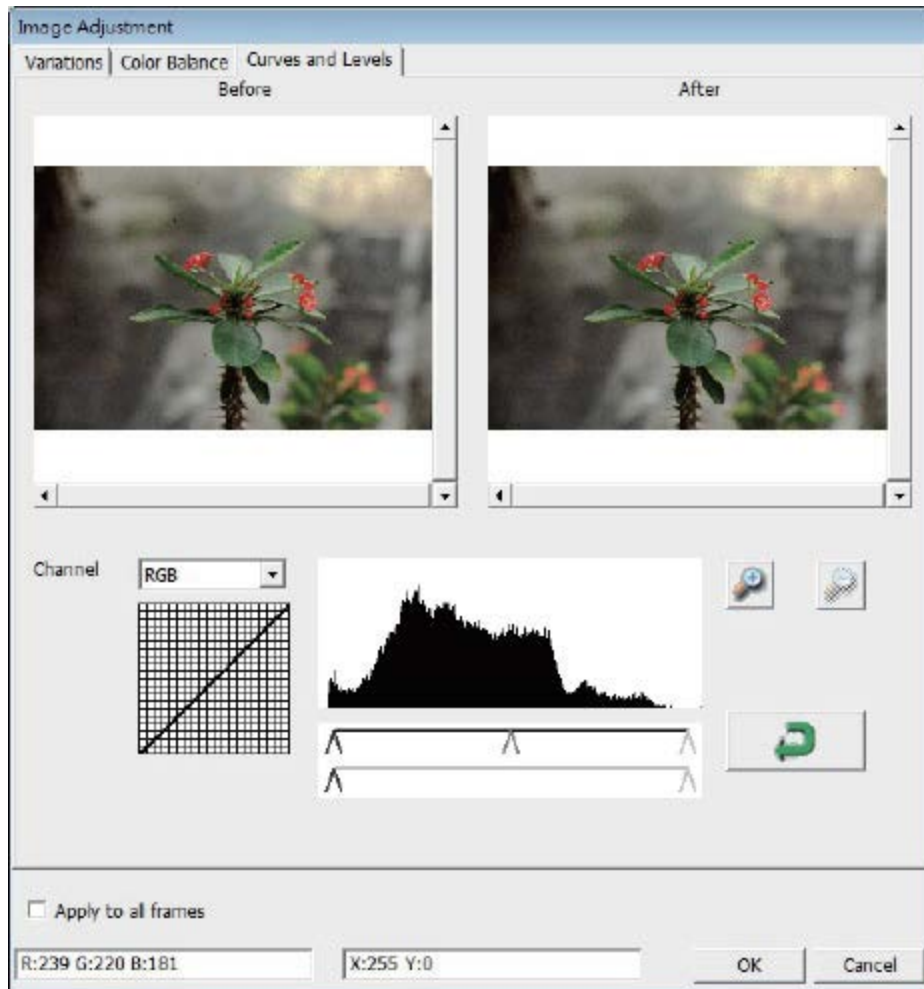

Example: When the previewed image appears to be too dark, adjustments with the Input slider in the Curves and Levels window can be made to correct the image. Selecting the Gray slider in the center and moving it to the left will result in changes in the "After" view resulting in a lighter image. Once the adjusted image is acceptable select "OK" to send changes to the scanning hardware. The same method can also be used to adjust each color channel independently, using the channel drop down menu "RGB = All colors" R = Red, G = Green, and B = Blue.

Menu Commands - Windows

1. Exposure Setting: To adjust the exposure time (R, G, B) press "Reset" to restore to the default setting.

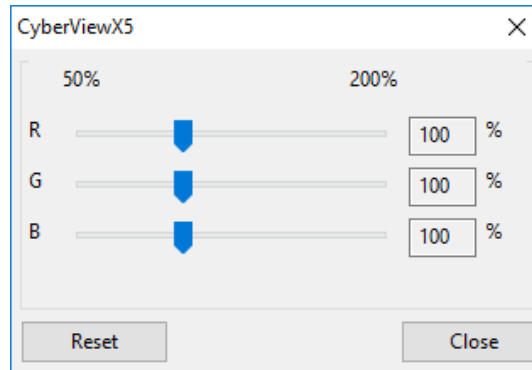

Menu Commands - Help

- **Update: Firmware:** Upgrade the firmware version, select the path where the file of firmware has been saved. (These files may be downloaded from our website)
- **About:** Displays system information (including operation system, CPU), product information (including product name, model name, hardware version, firmware version, software version, device information including interface and optical resolution).

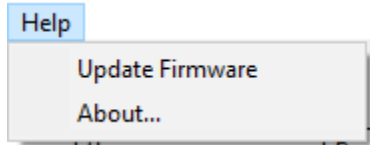

Function Bar Diagram

Please select your film type and brand from the toolbar:
Negative, Positive (also known as Slide)
Black and White

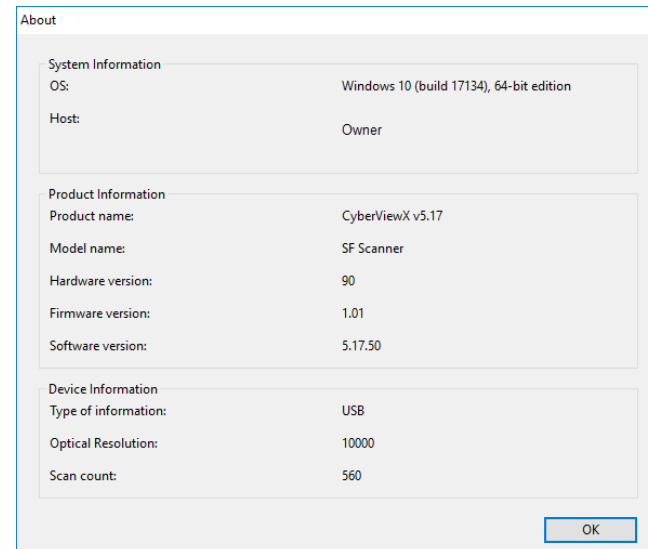
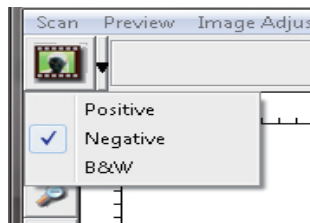

II. Preview Window Area [Fixed Windows]



Prescan: Pre-scans the current film, or press drop down for more options.



Scan: Scan film, begins the scan process or press drop down button for more options



Image Adjustment: Accesses the image adjustment area after a Prescan has been performed
Press drop down button for more options.



Preference : Accesses the scan settings area

CyberView X Left Tool bar diagram

These tools become available when an image is prescanned first

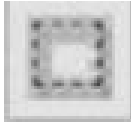

Crop Tool: Select scan area: more than one selection can be made at a time.



Zoom In: To magnify the image where the cursor is currently located. The image will be magnified with every click until the maximum multiple (1000%) is reached.



Zoom Out: To reduce the size of the viewed image click the Zoom Out cursor to the desired area, the image will reduce by half with every click until the lowest multiple (25%) is reached.



Rotate 90 Left: To rotate the image counter clockwise 90 degrees.



Rotate 90 Right: To rotate the image clockwise 90 degrees.

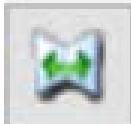

Flip Horizontal: To Flip the image 180 degrees horizontally.



Flip Vertical: To Flip the image 180 degrees vertically.

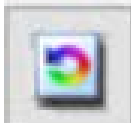

Revert: Discard all modifications and restores the image back to the original state in preview windows.

II. Preview Window Area [Fixed Windows] (Continued...)

CyberViewX5-Super Edition

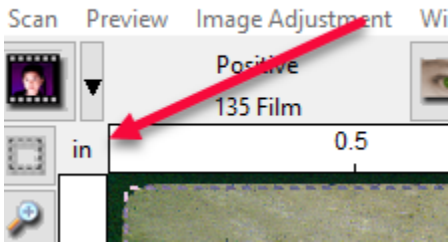

You can select the ruler measurement unit "in"- "cm"- "px" by clicking the upper left corner.

Scan Setting

Scan

Scan Mode: Normal

1000 DPI

Width: 1437.00 Height: 957.00

Color Depth: 8 bit

Advanced>>

Information

...\5000 dpi scans\

Open File Location

Left : 0

Top : 0

Width : 1437.00 pxl

Height : 957.00 pxl

Size : 3.93 MB

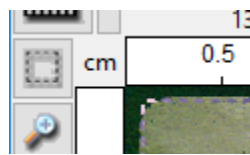

Width : 3.43 cm

Height : 2.28 cm

Size : 3.47 MB



Width : 1.35 inch

Height : 0.90 inch

Size : 3.47 MB

Status Line

In the lower left hand corner, the color level (RGB: red, green, blue) and coordinates of the location are displayed. The zoom scale, the current frame location and how many areas selected to scan (if you see Selections 2 or higher indicates: Multiple scan areas on one slide [ex: II]).

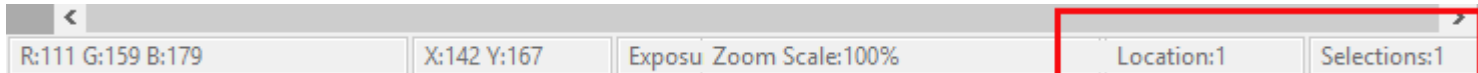

III. Scan Setting Area [Floating Windows]

Normal mode: [ex: I] to input the basic parameter to scan (including scan resolution, film size, color depth).

Advanced mode: [ex: II] Allows you to input the parameter of scan **output**, scan resolution

Apply to All : Applies settings made in this window only to all frames

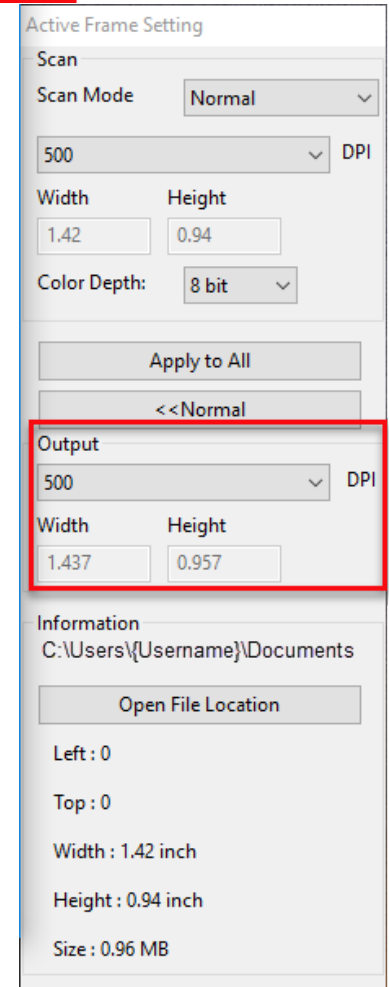
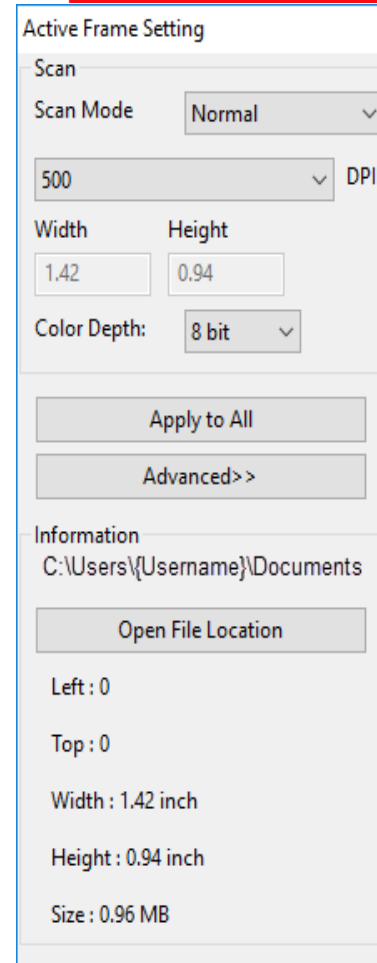

III. Scan Setting Area [Floating Windows] **Normal** (continued...)

Scan Mode Normal: Scans using normal speeds, **Fast:** Scans 30% faster, **Quality:** Scans slower for more detailed images such as optical and dental x-rays

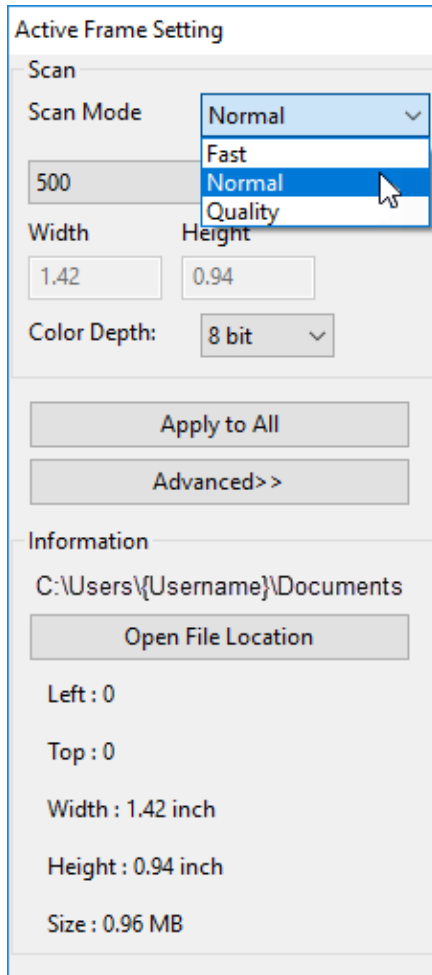

DPI: Set your scanning resolution

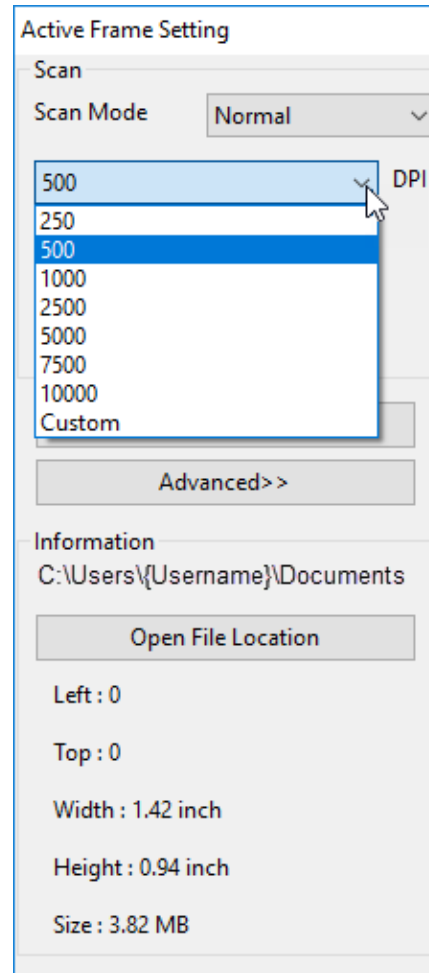

Color Depth: 8 or 16 bits per color Channel, resulting in a 24 or 48 bit image

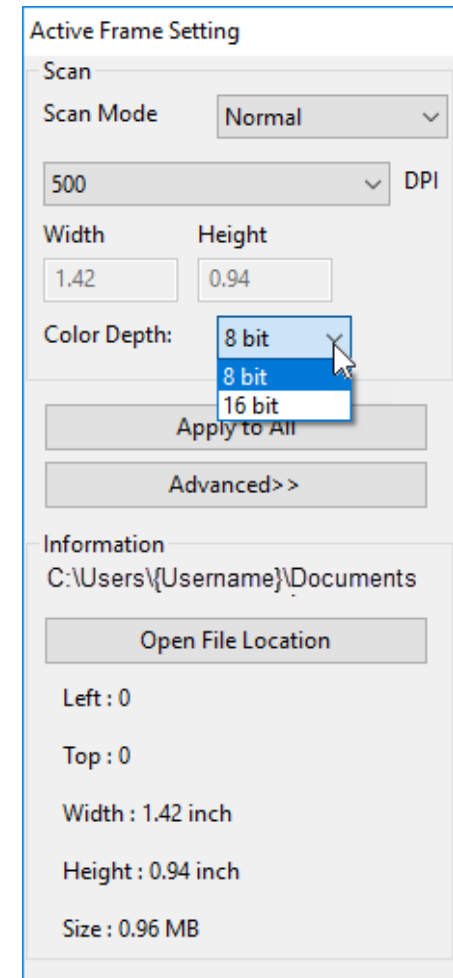

TECHNICAL SUPPORT

CyberView

For more information on our film scanners, please visit [Pacific Image Electronics](#)

For Support and driver updates

[Driver and Firmware updates](#)

[Contact Us](#)